

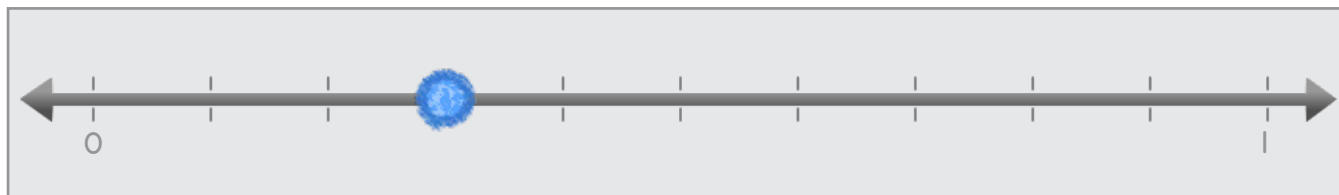

# Coloca el punto correspondiente.

Ejemplo



0.3

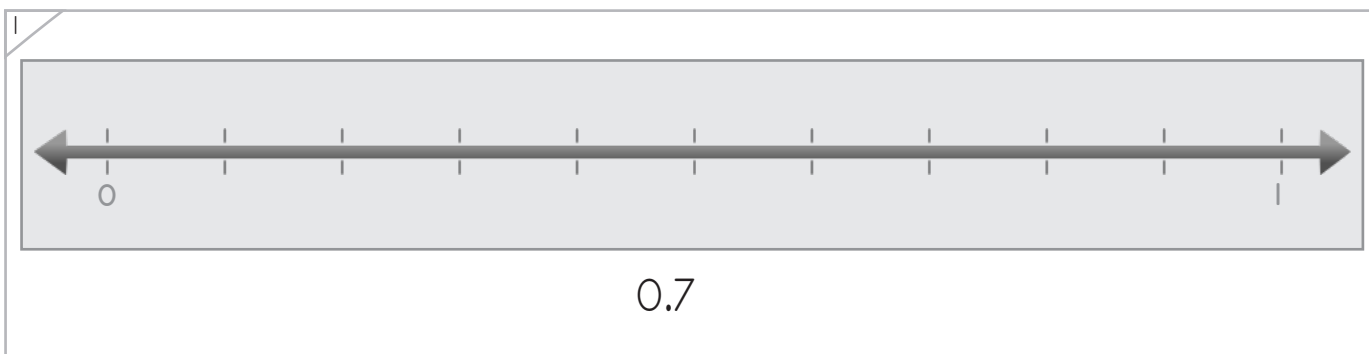

0.7

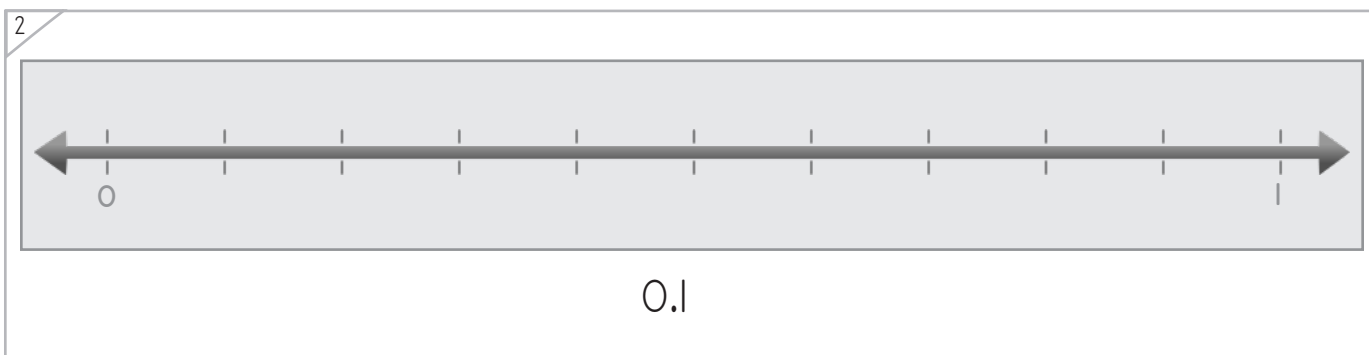

0.1

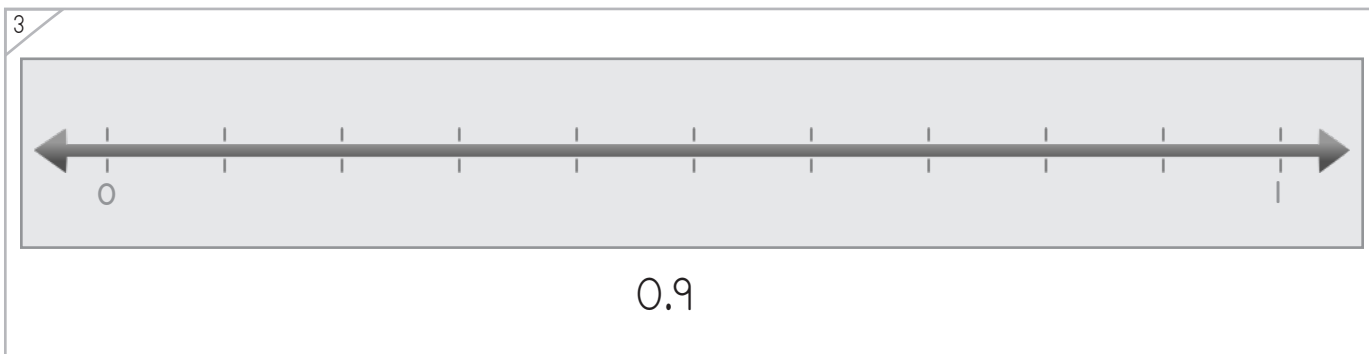

0.9





# Coloca el punto correspondiente.

Ejemplo

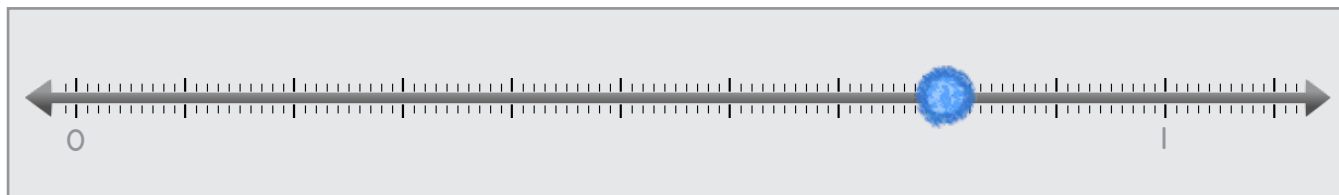

0.70

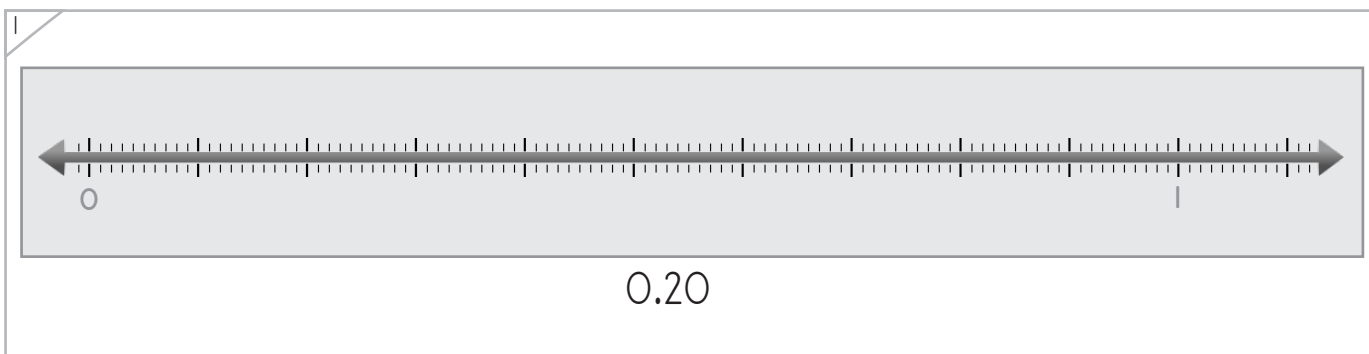

0.20

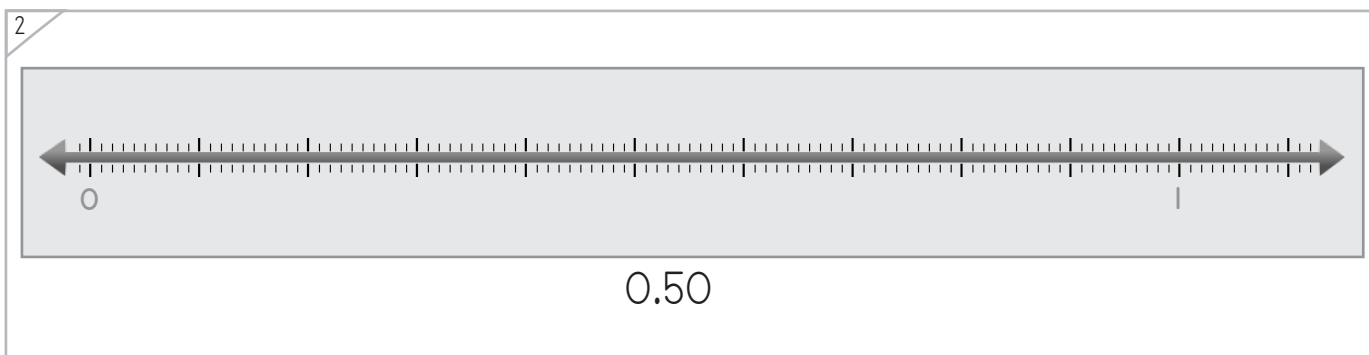

0.50

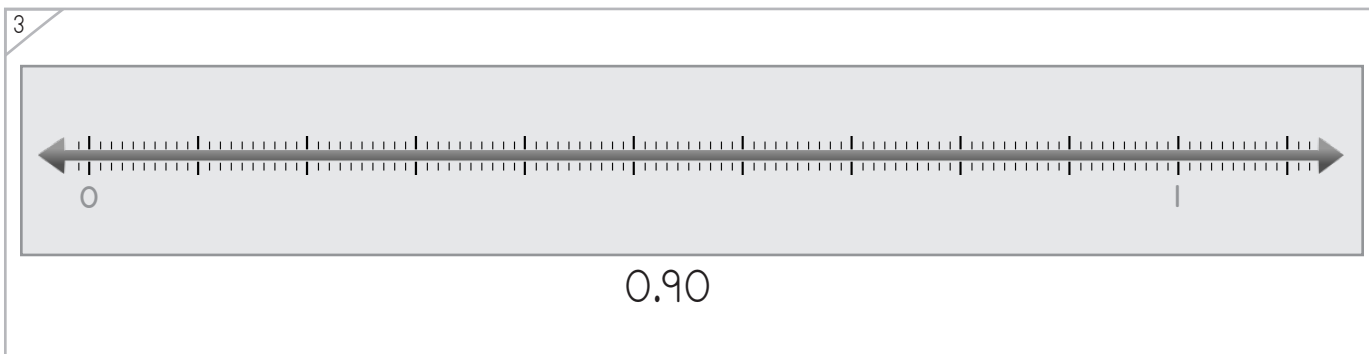

0.90



Nombre: \_\_\_\_\_ Fecha: \_\_\_\_\_



Ilumina las barras correspondientes.

Ejemplo



0.6

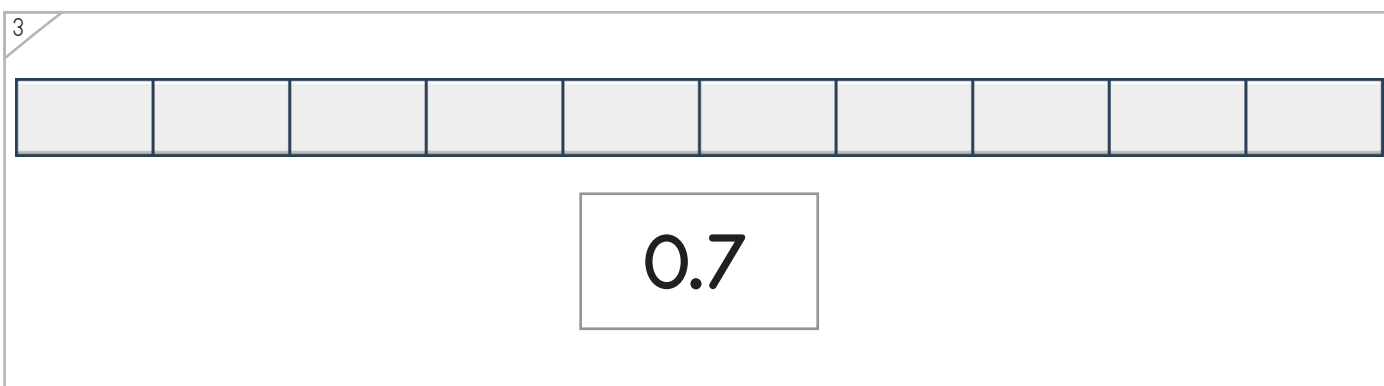
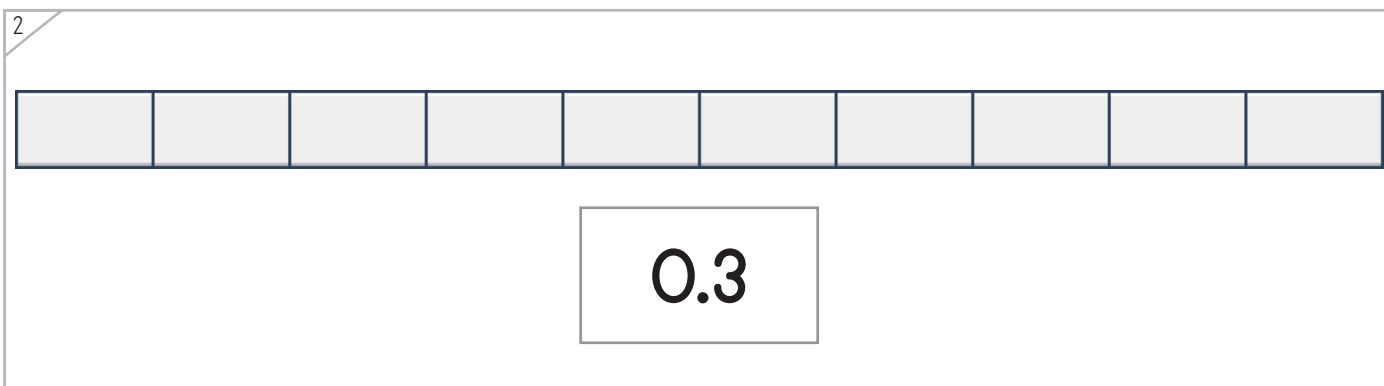
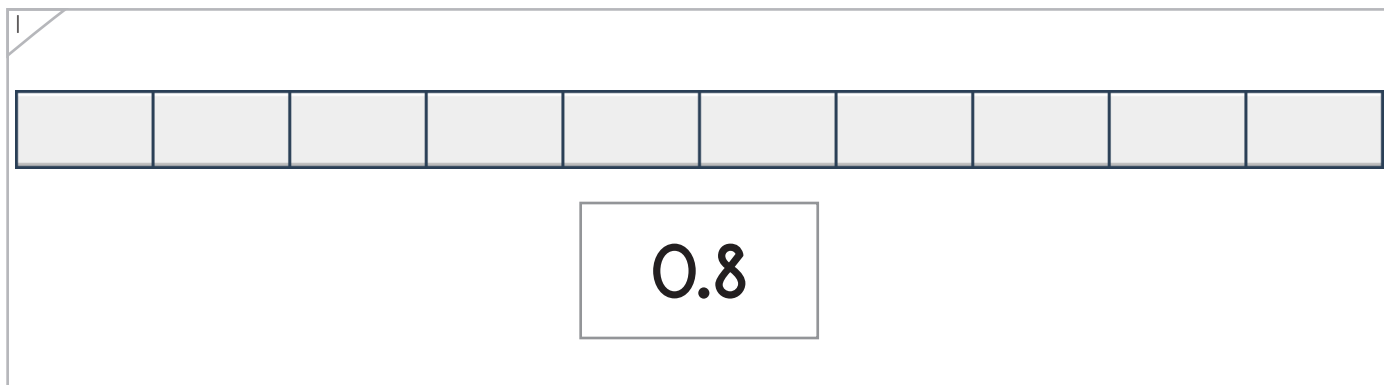

Copyright© 2017 Symphony Learning LLC. Se concede permiso para reproducir esta hoja para uso en el aula.



Nombre: \_\_\_\_\_ Fecha: \_\_\_\_\_



Ilumina las barras correspondientes.

Ejemplo



0.80



0.40



0.50



0.70



Escribe el decimal que falta.

Ejemplo



0.8

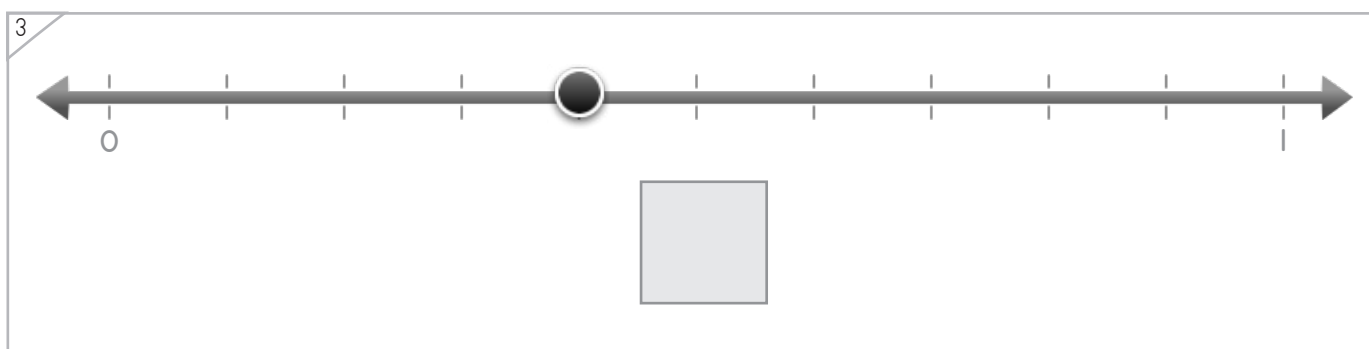
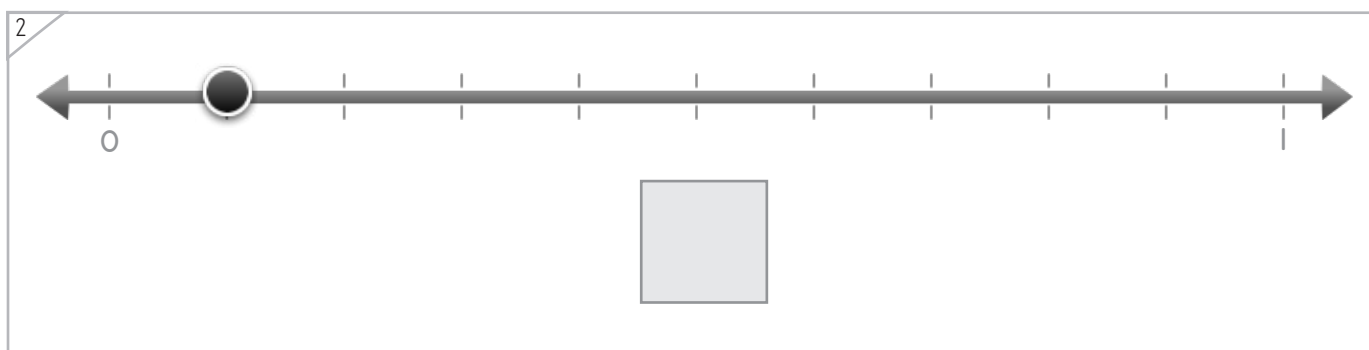
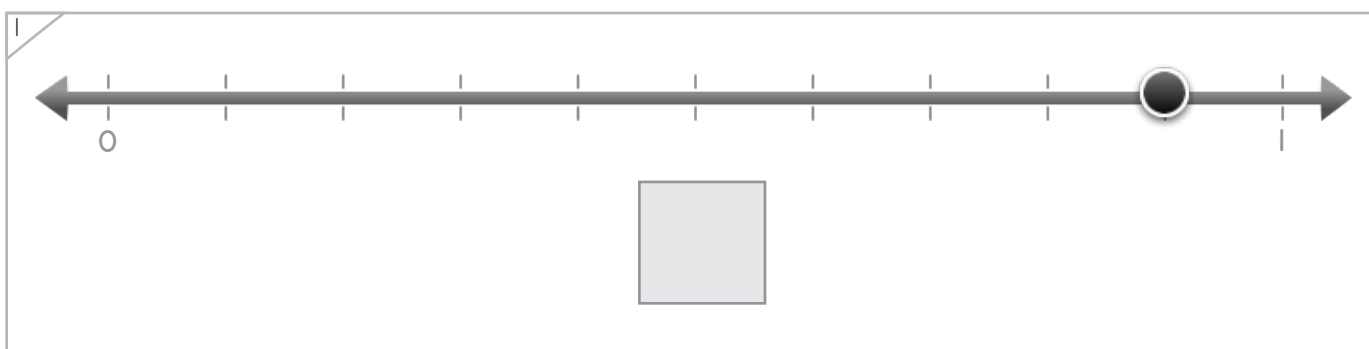

Escribe el decimal que falta.

Ejemplo

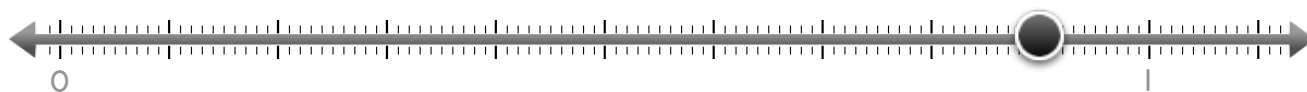

0.90

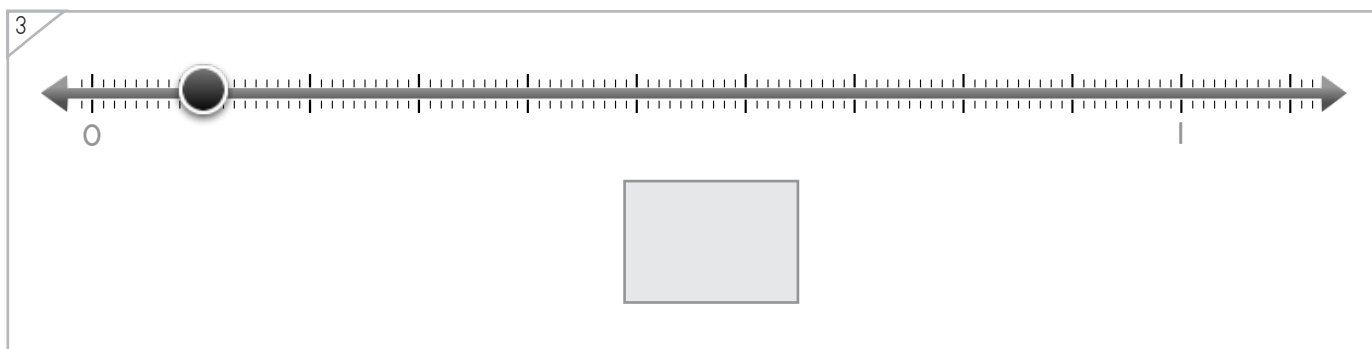
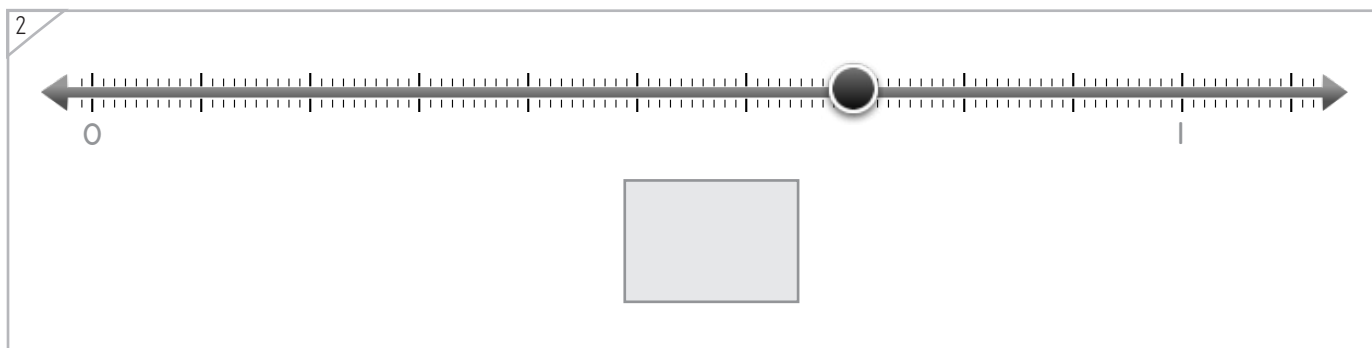
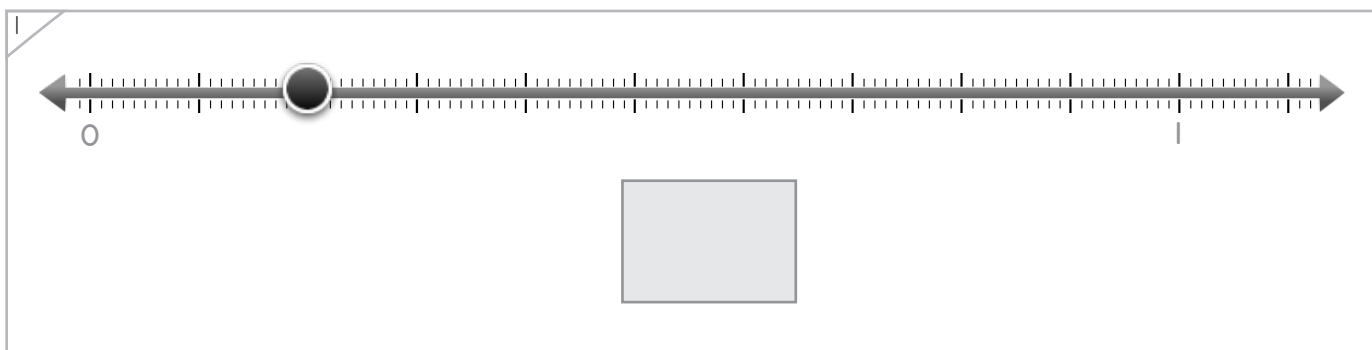

Nombre: \_\_\_\_\_ Fecha: \_\_\_\_\_

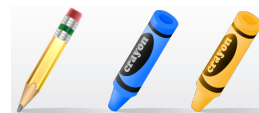

Manipulables y Símbolos

Ilumina las barras y escribe las fracciones correspondientes.

Ejemplo



0.6

1

\_\_\_\_\_

2

\_\_\_\_\_

3

\_\_\_\_\_

Copyright© 2017 Symphony Learning LLC. Se concede permiso para reproducir esta hoja para uso en el aula.



Nombre: \_\_\_\_\_ Fecha: \_\_\_\_\_

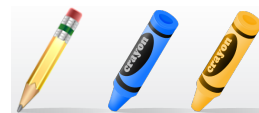

Manipulables y Símbolos

Ilumina las barras y escribe las fracciones correspondientes.

Ejemplo



0.30

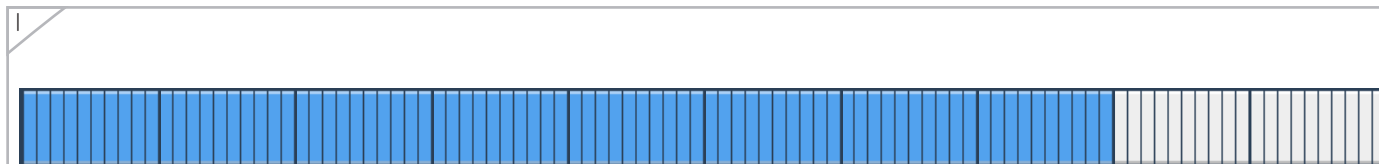

0.40

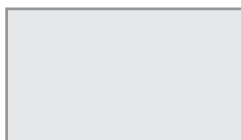

Copyright© 2017 Symphony Learning LLC. Se concede permiso para reproducir esta hoja para uso en el aula.

